



BA-Nr.: 02.07.132/2021-11-A01



**REBOTEC®** Rehabilitationsmittel GmbH  
DE-49610 Quakenbrück, Artlandstr. 57-59  
Telephone: +49 (0) 5431/9416-  
Fax: +49 (0) 5431/9416-66  
Web: [www.rebotec.de](http://www.rebotec.de)  
Email: [info@rebotec.de](mailto:info@rebotec.de)



## User Manual

# Shower and toilet wheelchairs - self-propelled

	Genf	Miami
<b>REF</b>	346.XX.YY	345.XX.YY
	130 kg	150 kg

XX= Colour code, YY= Equipment variant



Figure similar



Read this User Manual **before using the device for the first time** and keep it at hand for the user as well as for future use and subsequent sales.



## Table of contents

### Shower and toilet wheelchairs - self-propelled..... 1

<b>1</b>	<b>Product description .....</b>	<b>3</b>
1.1	Introduction .....	3
<b>2</b>	<b>Features .....</b>	<b>3</b>
2.1	Intended purpose .....	3
2.2	Conditions of use .....	3
<b>3</b>	<b>Storage &amp; transport.....</b>	<b>4</b>
3.1	Equipment & functions .....	4
3.2	Packaging .....	4
3.3	Disposal .....	4
<b>4</b>	<b>Symbols &amp; nameplates .....</b>	<b>4</b>
<b>5</b>	<b>Safety instructions .....</b>	<b>4</b>
<b>6</b>	<b>Incident reporting.....</b>	<b>5</b>
<b>7</b>	<b>Warranty.....</b>	<b>5</b>
7.1	Complaint.....	5
<b>8</b>	<b>Reuse, lifetime .....</b>	<b>6</b>
<b>9</b>	<b>Scope of delivery.....</b>	<b>6</b>
<b>10</b>	<b>Setting up for use.....</b>	<b>6</b>
10.1	Folding down the footrests .....	6
10.2	Adjusting the footrest height .....	6
10.3	Assembling the backrest.....	6
10.4	Assembling the 24" wheel.....	6
10.5	Fitting the parking brakes .....	7
<b>11</b>	<b>Product data .....</b>	<b>7</b>
<b>12</b>	<b>Operation of the product .....</b>	<b>7</b>
12.1	Sitting down.....	7
12.2	Getting up .....	7
12.3	Operation of the parking brake wheel, 24" 8	8
12.4	Swivelling the armrests .....	8
12.5	Removing the footrests .....	8

12.6	Removing the shower/ toilet seat.....	8
12.7	Handling of the toilet bucket .....	8
12.8	Operation of the parking brake wheel, 24" 8	8
12.9	Tilt and fall protect.....	9
<b>13</b>	<b>Troubleshooting.....</b>	<b>9</b>
<b>14</b>	<b>Care and maintenance.....</b>	<b>9</b>
14.1	Cleaning and care .....	9
14.2	Maintenance .....	9
<b>15</b>	<b>Spare parts &amp; accessories .....</b>	<b>10</b>
<b>16</b>	<b>Drawing &amp; dimensions .....</b>	<b>12</b>

## 1 Product description

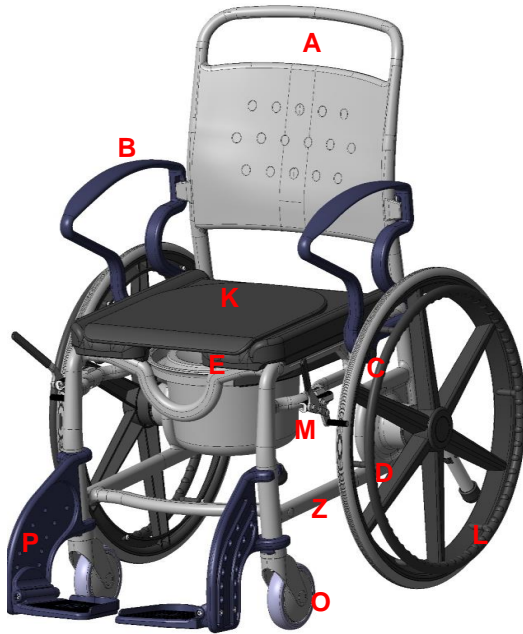

Figure shows:

A	Backrest
B	Armrest (foldable)
C	Locking bolts
D	Chair frame
E	PUR seat, hygiene opening
F	Shower seat
G	Toilet seat (foldable)
K	PUR seat cushion (removable)
L	Wheel 24"
M	Parking brake
O	Wheel 5", unbraked
P	Foot support with footrest (adjustable)
V	Toilet bucket with lid
Z	Nameplate

### 1.1 Introduction

- The product described here is a medical device of risk class I according to **(EU) 2017/745 MDR**.
- In this user manual, you will find information on the safe and proper initial operation, use, maintenance and care of this product.
- Carefully read this user manual before using the device. Follow the safety instructions and act accordingly.

## 2 Features

### 2.1 Intended purpose

#### Genf, Miami

- The product is intended for the care of patients with limited ability to stand and/or walk. It ensures showering while sitting and going to the toilet, even if a conventional toilet or bathroom is out of reach. If designed appropriately, it can be slid over a conventional toilet. The patient must have sufficient sitting ability and upper body musculature. If necessary, a nurse must be present during use. The product is not intended for prolonged sitting and transfer.

#### Specification - Genf:

- Maximum user weight: 130 kg
- Height adjustable footrests
- Self-propelled, rear wheels lockable
- Indoor use

#### Specification - Miami:

- Maximum user weight: 150 kg
- Height adjustable footrests
- Self-propelled, rear wheels lockable
- Indoor use

#### Indication

- Medical condition of the patient:
- The use of a chair by patients with cognitive disorders (reduced mental, physical, sensory or intellectual abilities) must be decided in advance by a medical decision (prescription of the product) or on site by the nursing personnel.

### 2.2 Conditions of use

- Temperature range: 5°C to 35°C; direct radiant heat on the product must be avoided.
- Relative humidity: 40% to 75%. Outside of these conditions, the product must only be used for a short time.
- This product may not be used to transport heavy objects.
- The chairs are not suitable for prolonged sitting.
- There must be a flat surface of sufficient size for the hoist to be placed on. See 16.
- The products can be slid over a conventional toilet. See 16.
- Use in domestic and inpatient settings.

### 3 Storage & transport

- Temperature range: 5 °C to 25 °C; direct radiant heat on the product must be avoided.
- Store the product in dry rooms with a humidity of up to 65%.
- The shower should be designed so that there is a flat surface of sufficient size.

#### 3.1 Equipment & functions

- The chairs consist of a plastic frame with a tube insert. The self-propelled chair has two 5" wheels with swivel castors at the front and two 24" wheels with push rims and parking brake at the rear.
- The armrests can be partially swivelled. The footrests are height adjustable and can be removed or folded down.
- The seat contains a toilet-like recess under which a toilet bucket with a lid can be inserted.

#### 3.2 Packaging

- We recommend you keep the packaging for a later transport.
- Dimensions: 740mm x 640mm x 640mm

#### 3.3 Disposal

- Disposal and recycling of used products and packaging must be carried out in accordance with currently valid regulations. Please contact a disposal company for further information.
- The Infection Protection Act must be observed.
- Please observe any labels and information on packaging material and act accordingly.

### 4 Symbols & nameplates

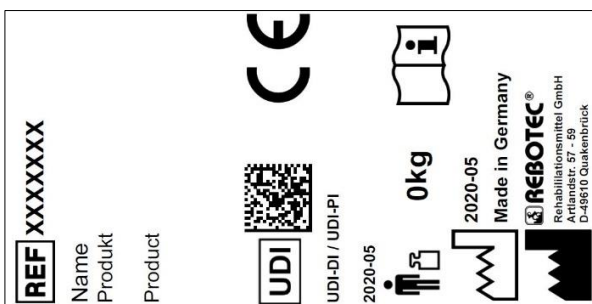

Figure similar.



*The nameplate must not be removed!*

*For ordering spare parts and processing complaints, the device name, serial number and year of manufacture will be required.*

Symbol	Meaning	Symbol	Meaning
	Read the manual!		Year of manufacture of Device
<b>SN</b>	Serial number		<i>Important information!</i>
<b>REF</b>	Article number		<i>Maximum user weight in kg</i>
	Care instructions		Maintenance instructions
	Applicable for indoor use only.		Manufacturer
	Visual signal	<b>EN</b>	Language
	Read the User Manual!		Do not dispose of as household waste.
<b>CE</b>	Product complies with <b>(EU) 2017/745 MDR</b>		
	Caution! Observe the safety instructions		
<b>UDI</b>	Unique Device Identifier (Data: GTIN / LOT (SN) / year of manufacture)		
<b>MD</b>	Medical device label This product is a medical device.		

### 5 Safety instructions



**Please observe the following safety instructions:**

- Before using the device for the first time, the User Manual must be read completely in order to avoid hazards or damage caused by maloperation.
- Before each use, check the device for visible damage or deficiencies.
- In case of malfunctions or damage of any kind, the device must not be used.

#### Caution: Danger of falling!

- The chair must only be used with the armrests locked in place when sitting and moving about.
- Sitting down, getting up, transferring of a patient should be done with the help of a trained caregiver, depending on the patient's state of health.

- Patients who are prone to uncontrolled actions or movements must be supervised when using the chair.
- The chair must **only** be moved on a slope or incline with the help of a caregiver. Generally, on an uphill slope the chair should be pushed forward and on a downhill slope it should be pulled backward.

#### Caution: Danger of slipping!

- Before use, check that the seat surfaces are firmly clamped in the seat frame.
- Always lock the parking brakes (both) on the 24" wheels (except while driving) before using the chair to prevent the chair from rolling away.
- When sitting down, do not sit on the front edge of the seat or on the seat cushion, but take up the entire seat surface.

#### Caution: Danger of tipping over!

- The chair must only be pushed by the push handle (backrest).
- The footrests must be swivelled down or folded up before sitting down/standing up. Do not stand on the footrests!
- Do **not** move the chair against door thresholds, edges or other uneven surfaces
- **Only** use the product indoors and on flat, skid-proof surfaces.
- **Only** move the chair at a moderate walking pace (with and without patients)
- Do not lean out of the chair (both in standstill and while moving). If the swivel castors are in an unfavourable position (pointing inwards), stability of the chair is limited.

#### Caution: Danger of breakage!

- The chair is **only** suitable for the intended use (see section 2). Observe the permissible max. body weight (information on the nameplate)!
- Never carry or lift the product while a patient is sitting on it.
- Do not pull or hold on to additionally attached components or accessories.

#### Caution: Danger of pinching or catching!

- When folding the armrests up or down, do not reach into the joint guide so that no parts of the body etc. are trapped.
- When attaching the seat plate, do not reach between the seat surface and the frame so that no body parts are trapped.

- When folding down the footrests, take care to avoid trapping any parts.
- When pulling out and pushing in the toilet bucket, there is a risk of trapping soft tissue of the patient. To prevent injuries, the bucket may only be pulled out or pushed in when no user is sitting in the chair.

#### Caution: Risk of injury!

- There is a risk of injury with surface temperatures > 40°C. Therefore, do not expose the product to high temperatures (e.g. sunlight, radiators, hot water). Allow the product to cool down before use.



*If the product is used by patients with insensitive skin (no temperature perception or skin damage), a heat check (e.g. touching with the back of the hand) must be carried out by the nursing staff.*

## 6 Incident reporting

- Serious incidents in connection with the product must be reported immediately to the manufacturer and BfArM.
  - BfArM: [www.bfarm.de/DE](http://www.bfarm.de/DE)
    - Use the reporting functions and provided forms.
  - Manufacturer: [pms@rebotec.de](mailto:pms@rebotec.de)

## 7 Warranty

- For this product the manufacturer grants a warranty of 12 months. Prerequisite are the general GTCs ([www.rebotec.de/agbs](http://www.rebotec.de/agbs)), as well as the intended use. The statutory warranty provisions shall apply.
- Unauthorised modifications to this product will void the product's conformity and the warranty.

### 7.1 Complaint

- Please contact us before returning the product.
- To reduce transport damage, use the original packaging if possible.
- The Infection Protection Act must be complied with.
- Please make sure that the product does not pose a risk of infection when returned.
- Enclose the supplied information sheet on safety with the product.
- Costs may incur for returns that are not marked non-objectionable.

## 8 Reuse, lifetime

- The product is suitable for reuse. How often the product can be reused depends on the frequency and nature of use.
- Before reuse, the product must be reprocessed hygienically and the technical and functional safety and reliability of the product must be checked and restored if necessary. See 14.
- For more detailed information, please see the reprocessing instructions (02.12.156) and the maintenance instructions (02.11.150).
- The documents can be downloaded from the following link.
  - [www.rebotec.de/downloads](http://www.rebotec.de/downloads)
- When used as intended, the product has a lifetime of 5 years. The effective lifetime may vary depending on the frequency and intensity of use and the general condition.

## 9 Scope of delivery

- 1 shower/toilet wheelchair, self-propelled
- 1 User manual (02.07.132)
- 1 Allen key

The reprocessing and maintenance instructions can be ordered or viewed and downloaded at [www.rebotec.de/downloads](http://www.rebotec.de/downloads).

## 10 Setting up for use

- The product has been carefully inspected in the factory for freedom from defects and completeness. Please check the product for any possible damage which may have occurred during transport and for completeness of the scope of delivery upon receipt. Assembly or adjustment shall be carried out by the specialist dealer.

### 10.1 Folding down the footrests

- Turn (1) the footrests forwards until they engage automatically. Fold (2) the footrests down. Adjust the height of the footrests if necessary.

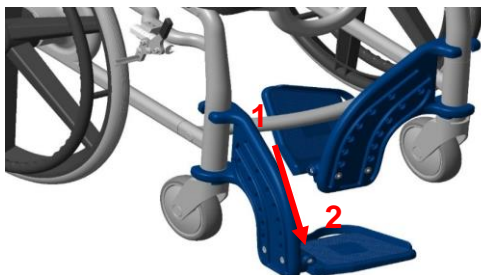

### 10.2 Adjusting the footrest height

- The footrest height can be adjusted in 7 positions. Loosen and remove the screws on the side of the footrest using an Allen key (SW 5). Select the appropriate height level (1-7) and screw the footrest back in place. Make sure that the screws are firmly tightened!

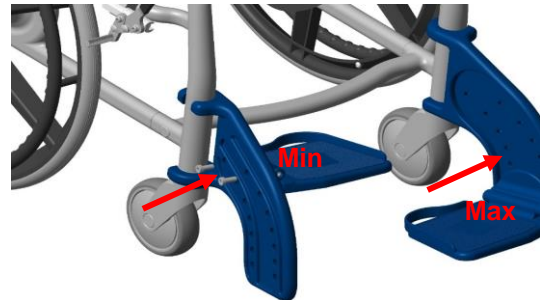

### 10.3 Assembling the backrest

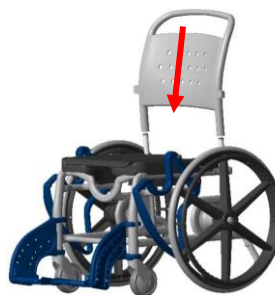

- The armrests must be swivelled backwards for mounting the backrest.
- Put the backrest on the tubes and then swivel the armrests forward until the bolts engage. See 12.4.

### 10.4 Assembling the 24" wheel

- Insert the screw from the outside (1) through wheel 24"
- Place the washer on the screw
- Hold the 24" wheel in front of the adapter socket and insert the screw through both parts
- Place the second washer on the screw from the inside
- Screw on the safety nut
- Tighten the nut (using 2 ring spanners, 19 mm)
- Tighten firmly but loose enough, so that wheel 24" still turns!
- Press on grey and black caps

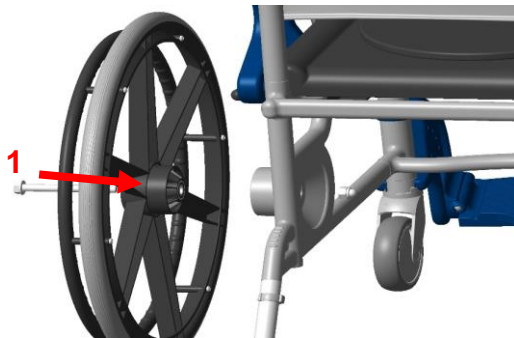

## 10.5 Fitting the parking brakes

- Loosen the two screws of the brake holder (1) until it can be pushed over the shoulder on the frame. Then push the brake holder up to the stop (2) and slightly tighten the two screws. Push the brake lever (3) through the brake holder opening and align it to be straight.

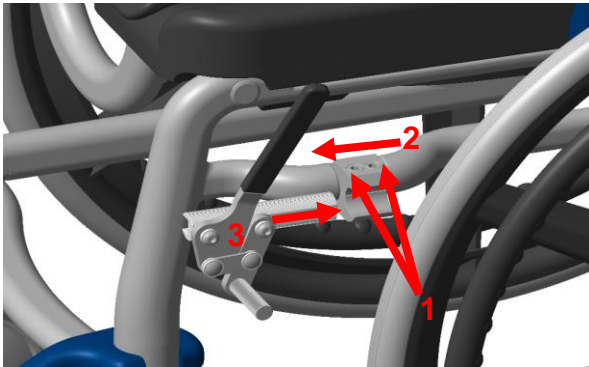

## 11 Product data

- We reserve the right to make technical developments and improvements with respect to the design shown in this User Manual. See 16.

Characteristic	Value
<b>Genf</b>	
2. Product weight*	23.2 kg
3. Total weight*	26.8 kg
<b>Miami</b>	
2. Product weight*	24.4 kg
3. Total weight*	28.2 kg
Skin compatibility	DIN EN 10993-1/-5
Flammability**	DIN EN 1021-1/-2

\*Without accessories.

## 12 Operation of the product

- Before use, it must be ensured that the product is in proper condition. If defects or malfunctions are evident, the product must not be used. Have the defects corrected by a specialist dealer before use.



If necessary, depending on the patient's limitations (adequate mobility and muscle strength), sitting down and getting up must be done with the help of a caregiver. Subsequent adjustments may only be made by qualified personnel!

### 12.1 Sitting down

- Before sitting down, make sure that the chair is securely positioned to prevent it from slipping or tipping over, 24" are braked, that the armrests are properly engaged, that the shower/toilet seat is firmly in place, and that the footrests are folded to the side or up.

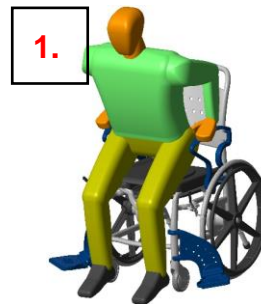

- The patient must position themselves as close as possible to the product. By supporting themselves on the two armrests, the patient should slowly sit down on the cushion.

- If this is not possible due to their physical limitations, support must be provided by the nursing staff. If necessary, the use of a lifting aid or patient lift is advisable.



**Caution: Danger of falling!**



- Falling down or slumping on the chair seat must be avoided. The patient should sit on the full chair surface, if possible, and not only on the edge of the seat.

- When transporting people, the entire surface of the backrest and the footrests must be used if possible.

### 12.2 Getting up

- Before getting up, make sure that the product is securely positioned to prevent it from slipping or tipping over (see: 10.9), that **both 24" wheels are braked**, that the armrests are properly engaged, and that the footrests are folded to the side or up.
- The patient should move forward on the chair so that their feet are on the floor.

3.



- The patient must support themselves with their arms on the armrests and slowly rise from the seat.
- Do not lean your body too far forward to avoid a potential risk of falling.

- The patient should be helped to stand up by the nursing staff.

**Caution: Danger of falling!**

4.



- The patient must never leave their feet on the footrests when sitting down or getting up.

### 12.3 Operation of the parking brake wheel, 24"

- Push the brake lever (1) all the way back. Loosen the Allen screws (2) of the parking brake only slightly with a spanner (SW 5). Push the parking brake up to approx. 25 mm in front of the wheel profile 24" and tighten the Allen screw.
- Check the function of the parking brake by pushing the lever forward. If the braking effect is still not sufficient, readjust (reduce or increase the distance).

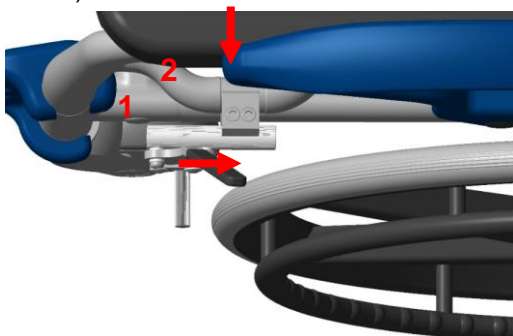

### 12.4 Swivelling the armrests

- Pulling out the locking bolts (A) releases the locking mechanism and the armrests can be swivelled backwards.

- When folding up the armrest, check that the catch on the backrest (B) and the locking bolt (A) are seated correctly. The armrests can be swivelled with both hands.
- To do this, keep the locking bolt (A) pulled during the entire swivelling process and guide the armrest to point (C) with the other hand. Only touch the outer area and do not reach into or through the armrest.

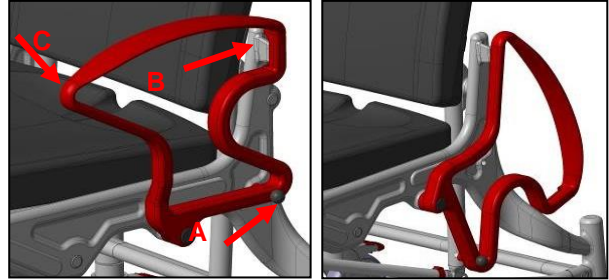

*Check the locking at regular intervals, as possible limescale deposits on the locking mechanism can impair function and smooth operation.*

### 12.5 Removing the footrests

- Remove or fold up the seat. Then, raise the footrest by approx. 100 mm and turn outwards by 90 degrees.
- Now you can push the footrest all the way up and pull it out.

### 12.6 Removing the shower/ toilet seat

- The seat can be removed from its locked position on the chair frame by lifting it off for cleaning or replacement.

### 12.7 Handling of the toilet bucket

- From the back of the chair, slide the toilet bucket under the seat. To remove, slightly lift the bucket and then pull it out backwards.

### 12.8 Operation of the parking brake wheel, 24"

- The parking brake on the 24" wheel is released by pulling (1) the lever backwards.

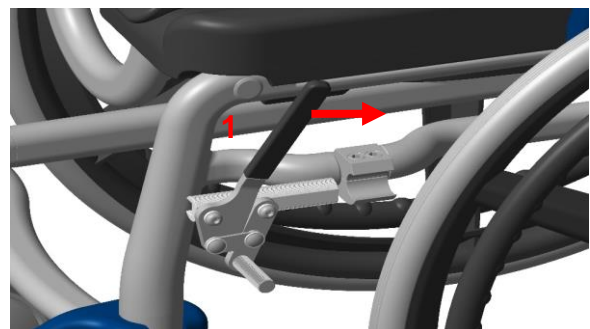

- Pressing (2) the lever forward brakes the 24" wheel. Push the lever all the way down!

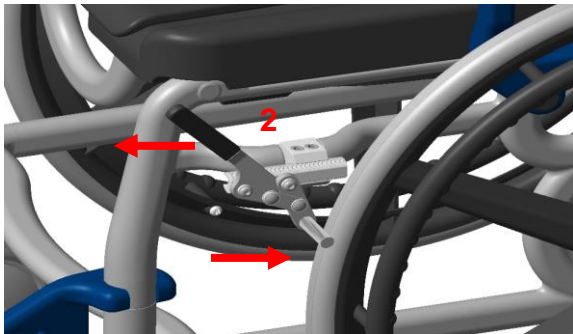

- If the braking effect is not sufficient or if the braking effect decreases after some time of use, it is necessary to adjust the parking brake.



*Individual setting and adjustment of the parking brake must only be carried out by the specialist dealer. This also applies to the replacement or repair of a parking brake.*

### 12.9 Tilt and fall protect

- To overcome obstacles, the self-propelled unit can be tilted backwards. This raises the front wheels and an obstacle can thus be overcome.
- Hold the backrest with both hands and tilt the chair backwards until the two support legs are almost on the floor.
- By pulling out the clip, the tilt protect tube can be pulled off

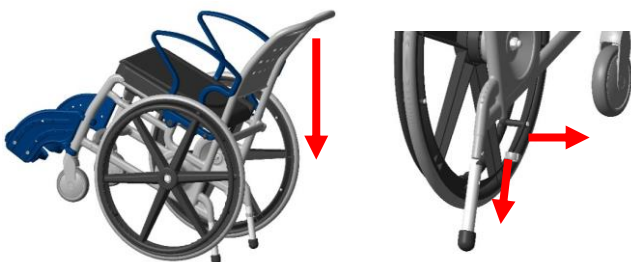

## 13 Troubleshooting

Fault	Potential cause	Remedy
Armrest cannot be swivelled down	Deposits in the locking device (locking bolt)	Cleaning, checking regularly
Locking bolt cannot be pulled out	Deposits, tension spring jammed or defective	Cleaning, Replace the locking bolt
Footrest cannot be folded down	Deposits in the joint, Bracing	Cleaning, Check screw connection
Wheel lock does not brake	General defect	see maintenance!

Fault	Potential cause	Remedy
Turning the wheel is stiff	Deposits	Cleaning
Wheel does not turn	General defect	see maintenance!
Uneven running of the wheel	Severe uneven tread wear	see maintenance!
Chair frame too unstable	Screw connections too loose	Screw connections: Tighten frame, wheel inserts
Wheel insert bent/distorted	Hitting an obstacle	see maintenance!

## 14 Care and maintenance

### 14.1 Cleaning and care



- The product can be cleaned using a mild conventional cleaning and disinfecting agent. After cleaning, wipe the product with a clean, moist cloth and then wipe it dry with a dry cloth.
- Do not use scouring agents or cleaning agents with aggressive ingredients (acids, thinners), as well as hard cleaning objects (brushes), as otherwise the surfaces may be damaged or deposits may form on the materials.
- The product is suitable for manual cleaning and disinfection. Please observe the reprocessing instructions (02.12.156).

### 14.2 Maintenance

- Wear and tear that is not recognised in time and/or improper handling, as well as irregular or no maintenance may result in accidents.



*For safety reasons, the product must be professionally maintained at **least once a year**.*

- Check product for visible damage (cracks, breaks, loose parts)
- Check stability before use

#### Maintenance/inspection scope

- Maintenance should include the following inspection work and should be documented.
- All bolted connections for tightness (especially the wheel inserts and the frame)
- Function of the armrests and locking bolts
- Function of the footrest (replace defective footrests)

- Running characteristics and tread of the wheels (replace defective wheels)
- Function of the parking brakes (replace defective brakes)
- Inspect accessories for deficiencies

#### Repair

- If you have any questions concerning the maintenance of the chair, please contact an authorised dealer or a medical and healthcare supplies store.
- In the event of damage and/or repairs, contact your authorised dealer immediately.
- **Never** make **any** unauthorised modifications or conversions to the chair. These will only adversely affect the safety and functioning of the chair.
- Only use OEM spare parts by the manufacturer REBOTEC for repairs. Observe all guarantee and warranty information.

- After maintenance or repair work has been carried out we recommend you clean the device for hygienic reasons before using it again.
- Follow all the instructions for ordering spare parts, reuse and the lifetime.



For documenting the maintenance and repair work, REBOTEC provides a Maintenance Report. *The operating instructions and maintenance log can be ordered or viewed via [www.rebotec.de](http://www.rebotec.de). There, it is also possible to print the information and read it when needed*

## 15 Spare parts & accessories

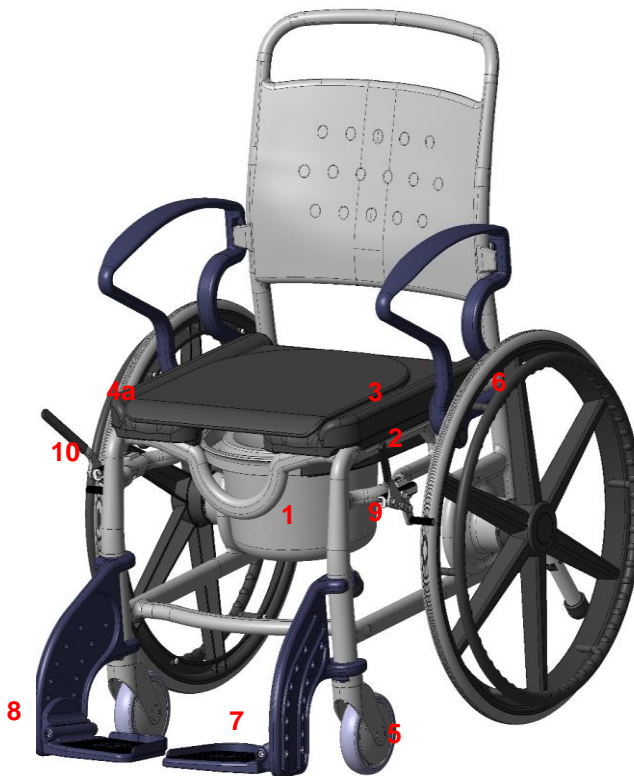



No.	Art. no.	Designation
1	301.00	Toilet bucket with lid
2	309.10	Bucket holder
3	440.XX.62	PUR lining mat for shower and toilet seat
4a	440.10.04	PUR shower seat
4b	308.00.60	Shower seat, standard
5	440.49.89	5" wheel without brake
6	450.10.05	Armrest engagement lock, complete
7	447.XX.57	Footrest complete, left
8	447.XX.59	Footrest complete, right
9	440.49.89	Parking brake, right
10	440.49.90	Parking brake, left
-	440.10.24	Shower seat, closed
-	440.10.32	PUR Arm support
-	440.10.40	PUR Splash protection
-	02.07.132	User Manual
-	02.11.150	Maintenance log
-	02.12.156	Reprocessing Instructions

**XX= Colour variant**

*Dimensions and weights may vary depending on the equipment. There might be minor deviations due to production tolerances. Subject to change without notice.*

## 16 Drawing & dimensions

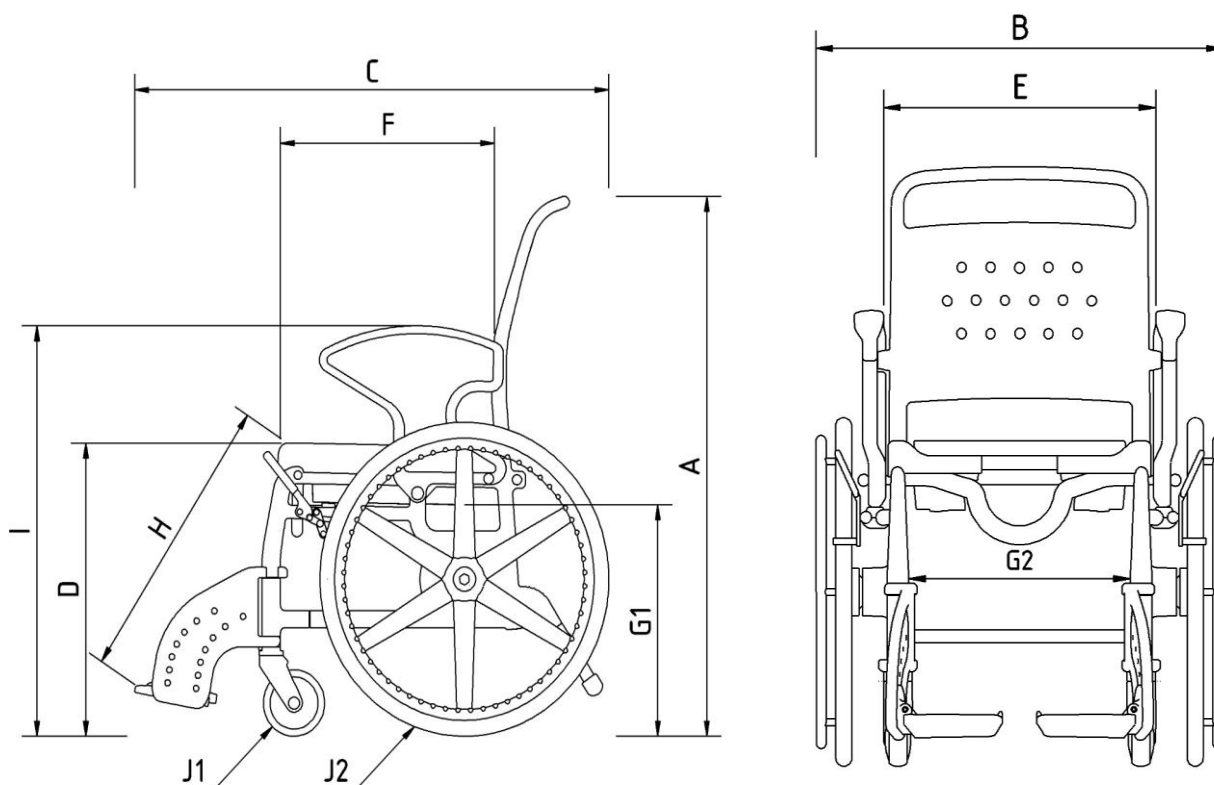

No.	Designation	Genf- dimensions / mm	Miami- dimensions / mm
A	Overall height	1010	1020
B	Overall width	710	770
C	Overall depth	950	950
D	Seat height	520 - 550	520-550
E	Width between armrests	460	530
F	Seat depth	410 - 450	410-450
G1	Slide-over height	450	450
G2	Slide-over width	385	450
H	Knee height of footrest max.	380 - 580	380 - 580
I	Armrest height	775 - 825	775 - 825
J1	Front castor diameter	125	125
J2	Rear castor diameter	600	600

Dimensions and weights may vary depending on the equipment. There might be minor deviations due to production tolerances. Subject to change without notice.